

HP 85051A 7mm VERIFICATION KIT

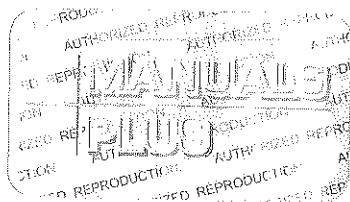

**HEWLETT
PACKARD**

CERTIFICATION

Hewlett-Packard Company certifies that this product met its published specifications at the time of shipment from the factory. Hewlett-Packard further certifies that its calibration measurements are traceable to the United States National Bureau of Standards, to the extent allowed by the Bureau's calibration facility, and to the calibration facilities of other International Standards Organization members.

WARRANTY

This Hewlett-Packard instrument product is warranted against defects in material and workmanship for a period of one year from date of shipment. During the warranty period, Hewlett-Packard Company will, at its option, either repair or replace products which prove to be defective.

For warranty service or repair, this product must be returned to a service facility designated by HP. Buyer shall prepay shipping charges to HP and HP shall pay shipping charges to return the product to Buyer. However, Buyer shall pay all shipping charges, duties, and taxes for products returned to HP from another country.

HP warrants that its software and firmware designated by HP for use with an instrument will execute its programming instructions when properly installed on that instrument. HP does not warrant that the operation of the instrument, or software, or firmware will be uninterrupted or error free.

LIMITATION OF WARRANTY

The foregoing warranty shall not apply to defects resulting from improper or inadequate maintenance by Buyer, Buyer-supplied software or interfacing, unauthorized modification or misuse, operation outside of the environmental specifications for the product, or improper site preparation or maintenance.

NO OTHER WARRANTY IS EXPRESSED OR IMPLIED. HP SPECIFICALLY DISCLAIMS THE IMPLIED WARRANTIES OF MERCHANTABILITY AND FITNESS FOR A PARTICULAR PURPOSE.

EXCLUSIVE REMEDIES

THE REMEDIES PROVIDED HEREIN ARE BUYER'S SOLE AND EXCLUSIVE REMEDIES. HP SHALL NOT BE LIABLE FOR ANY DIRECT, INDIRECT, SPECIAL, INCIDENTAL, OR CONSEQUENTIAL DAMAGES, WHETHER BASED ON CONTRACT, TORT, OR ANY OTHER LEGAL THEORY.

ASSISTANCE

Product maintenance agreements and other customer assistance agreements are available for Hewlett-Packard products.

For any assistance, contact your nearest Hewlett-Packard Sales and Service Office. Addresses are provided at the back of this manual.

HP 85051A

7mm VERIFICATION KIT

This manual pertains to verification kits that have serial number prefix 2340A. For kits having other prefixes obtain a Manual Changes supplement from Hewlett-Packard.

Some devices in this kit have their own unique serial numbers. These serial numbers correspond to the information on the device characterization data sheets that come with this kit.

©Copyright HEWLETT-PACKARD COMPANY 1984
1400 FOUNTAINGROVE PARKWAY, SANTA ROSA, CA 95401 U.S.A.

Manual Part Number 85051-90001
Microfiche Part Number 85051-90002

Printed: APRIL 1984
Printed in U.S.A.



**HEWLETT
PACKARD**

SAFETY CONSIDERATIONS

GENERAL

This product and related documentation must be reviewed for familiarization with safety markings and instructions before operation. This product has been designed and tested in accordance with international standards.

SAFETY SYMBOLS



Instruction manual symbol: the product will be marked with this symbol when it is necessary for the user to refer to the instruction manual (refer to Table of Contents).



Indicates hazardous voltages.



Indicates earth (ground) terminal.

WARNING

The **WARNING** sign denotes a hazard. It calls attention to a procedure, practice, or the like, which, if not correctly performed could result in personal injury. Do not proceed beyond a **WARNING** sign until the indicated conditions are fully understood and met.

CAUTION

The **CAUTION** sign denotes a hazard. It calls attention to an operating procedure, practice, or the like, which, if not correctly performed or adhered to, could result in damage to or destruction of part or all of the product. Do not proceed beyond a **CAUTION** sign until the indicated conditions are fully understood and met.

SERVICING

WARNING

Any servicing, adjustment, maintenance, or repair of this product must be performed only by qualified personnel.

TABLE OF CONTENTS

	Page
Introduction	1
Scope of This Manual	1
Getting Started Check List	2
Replaceable Parts	5
Environmental Requirements	5
Safety Considerations	6
Visual and Mechanical Examinations	8
Visual Examination	8
Mechanical Examination	9
Examination Failures	11
Loading the Data Cartridge	12
Connection Procedures	13
Typical Verification Results	16
Mechanical Dimensions	19
Connector Life	21
Further Information	21
WARRANTY	Inside Front Cover
SAFETY CONSIDERATIONS SYMBOLS	Facing Table of Contents
HP SALES/SUPPORT OFFICES	Inside Back Cover

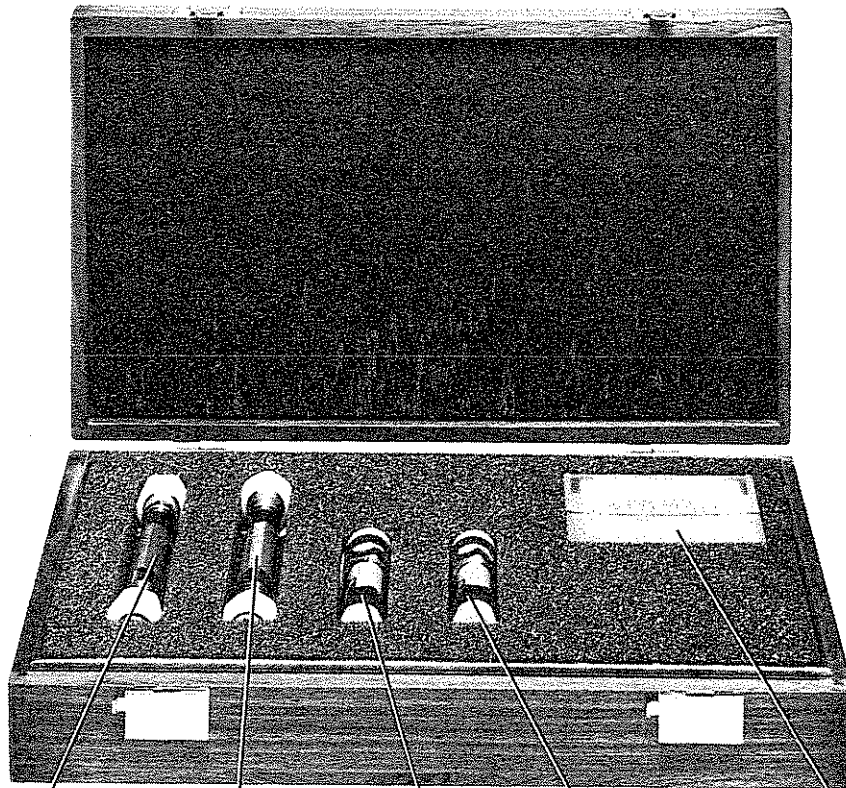

10cm BEADLESS AIRLINE
HP Part Number 1250-1880 CD 8
CENTER CONDUCTOR TIPS
Maury Part Number 2600-75

20 dB ATTENUATOR
HP Part Number 85051-60001 CD 2

DATA TAPE
No Replacement Available
Blank Tape:
HP Part Number 98200-67000 CD

STEPPED IMPEDANCE LINE
HP Part Number 1250-1882 CD 0
CENTER CONDUCTOR TIPS
Maury Part Number 2600-75

50 dB ATTENUATOR
HP Part Number 85051-60002 CD 3

STORAGE CASE
HP Part Number 85051-80001 CD 4

NOT SHOWN

6-SLOT CENTER COLLETS
HP Part Number 85050-20001 CD 7

PROTECTIVE END CAPS, PUSH-ON
HP Part Number 1401-0123 CD 1

DATA ENVELOPE
HP Part Number 9230-0223 CD 7

OPERATING AND SERVICE MANUAL,
with **MANUAL CHANGES SUPPLEMENT (IF NECESSARY)**
HP Part Number 85051-90001 CD 5

HP 85051A 7mm VERIFICATION KIT

INTRODUCTION

The HP 85051A 7mm verification kit contains devices to verify that an HP 8510 network analyzer is working properly.

A verification consists of measuring these kit devices on your HP 8510 network analyzer, then comparing your measured data with the factory-measured data. If your measurements agree with the factory measurements then the network analyzer system is operating correctly.

The S-parameter electrical performance of each verification device has been individually measured at the factory, and the resultant data is included with your kit both on a magnetic tape and on device characterization data sheets. The data sheets also show the reasonable tolerance window you can expect during measurements (± 3 standard deviations).

SCOPE OF THIS MANUAL

This manual is a continuation of the HP 85050A 7mm calibration kit Operating and Service Manual. The calibration kit manual contains a detailed explanation of the general examination, gaging, and connection procedures that should be used for *all* precision 7mm devices. This manual explains only verification kit devices. Together, these two manuals explain all of the Hewlett-Packard recommended procedures for making good 7mm connections.

However, you will also need specific operating instructions for using these devices with the HP 8510 network analyzer. Instructions for the calibration procedure is contained in Section III (Operating and Programming) of the HP 8510 Operating and Service Manual, while the verification procedure is explained in Section IV (Performance Tests).

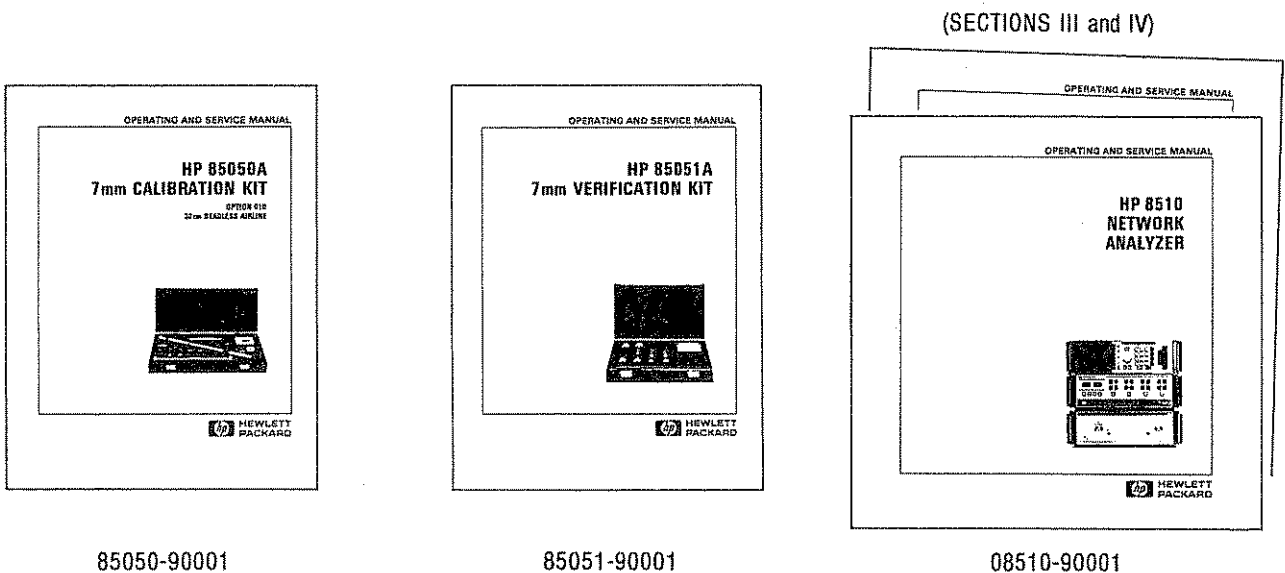

GETTING STARTED CHECK LIST

Please examine your new verification kit in the sequence described below.

1. Unpack your kit from the shipping container, and compare the contents to what is shown in the frontispiece illustration. If any components are missing or damaged, contact Hewlett-Packard for immediate repair or replacement.

CAUTION

If *any* component of this kit, including the storage case, arrives in damaged condition assume that *all* other devices are also damaged until you have checked their performance. Any shock that is strong enough to damage one of the devices could easily have damaged the others.

Be especially cautious if you suspect that a connector is damaged, because it could subsequently cause a ruined port connector on a test set.

2. Compare the serial number *prefix* (first four digits) on your verification kit with the prefix listed on the Title Page of this manual. If the prefixes are different, a Manual Changes Supplement should accompany your kit that explains the differences and corrects any errors in this manual.

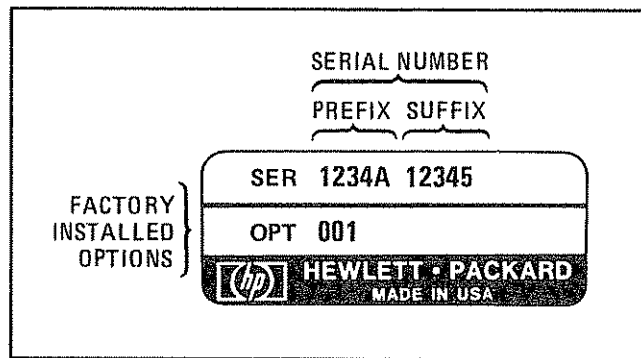

3. Obtain the other equipment that is required, but not supplied:
 - 7mm connector gage kit
 - 12 pound-inch (136 N-cm) torque wrench
 - Illuminated magnifying glass
 - Compressed air for cleaning connectors
 - Trichlorotrifluoroethane (liquid Freon) cleaning solvent
 - Foam-tipped cleaning swabs
 - Lint-free cloth or cleaning tissue

REQUIRED

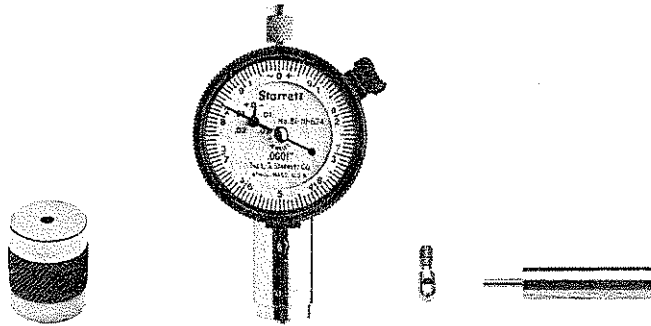

7mm CONNECTOR GAGE KIT
HP Part Number 1250-1875 CD 1

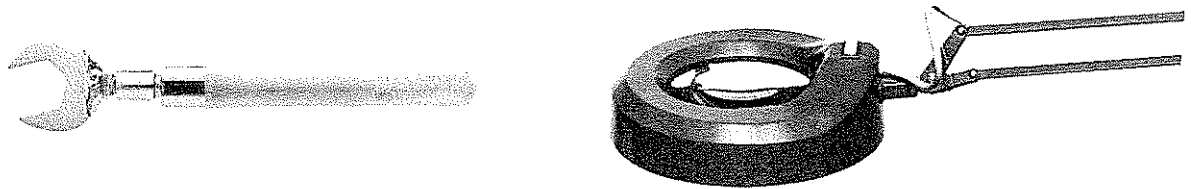

TORQUE WRENCH
12 lb-in (136 N-cm)
HP Part Number 1250-1874 CD 0

ILLUMINATED 4-POWER
MAGNIFYING GLASS
(Not available from HP)

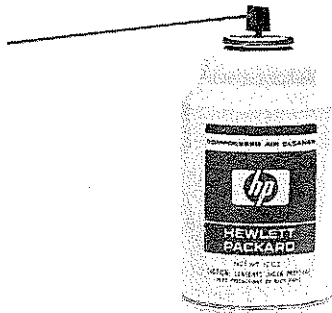

COMPRESSED AIR
HP Part Number 92193Y



TRICHLOROTRIFLUOROETHANE
HP Part Number 8500-1914 CD 7



FOAM-TIPPED SWABS
HP Part Number 9300-0468 CD 1 (Package)

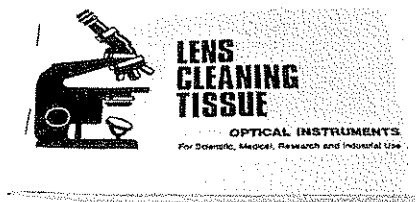

LINT-FREE CLEANING TISSUE
HP Part Number 9310-4242 CD 8

4. For some applications, the following are useful:
- HP 11591A 7mm connector repair kit, especially the 9/16" thin-blade, open-end wrench which it contains
 - 3.5mm connector gage kit
 - SMA connector gage kit
 - Torque wrench for 3.5mm connectors (8 lb-in, 90 N-cm)
 - Torque wrench for SMA connectors (5 lb-in, 56 N-cm)

USEFUL

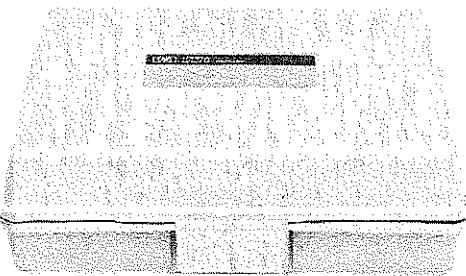

HP PART NUMBER 11591A
7mm CONNECTOR REPAIR KIT

ALSO AVAILABLE
SMA CONNECTOR
GAGE KIT
Maury Part Number A-027A

TORQUE WRENCH FOR SMA CONNECTORS
5 lb-in (56 N-cm)
HP Part Number 8710-1582 CD 0

TYPE-N CONNECTOR
GAGE KIT
Maury Part Number A-020A

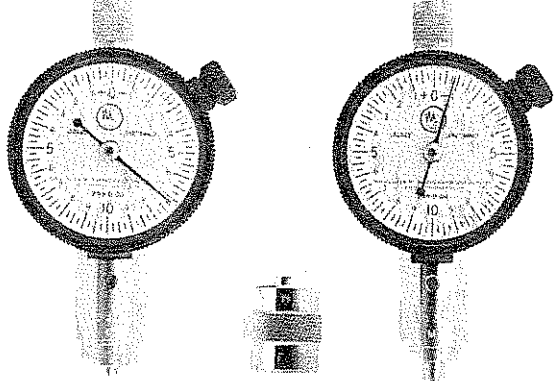

3.5mm CONNECTOR GAGE KIT
HP Part Number 1250-1862 CD 6



TORQUE WRENCH
For 3.5mm CONNECTORS 8 lb-in (90 N-cm)
HP Part Number 1250-1863 CD 7

5. Consider ordering at this time extra 6-slot center collets and tips for the airline center conductor. These two items are subject to wear, and are the two items most frequently lost or damaged by operators.

RECOMMENDED

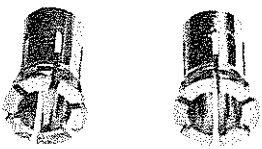

6-SLOT CENTER COLLET
HP Part Number 85050-20001 CD7



AIRLINE CENTER CONDUCTOR TIPS
Maury Part Number 2600-75

6. Also consider making a back-up copy of the data tape at this time. The data tape contains information that is unique to the devices in your kit, and if the tape is damaged a replacement does not exist. Section III (Operating and Programming) of the HP 8510 network analyzer manual explains tape duplication procedures. If your tape becomes damaged, and if a back-up tape was not made, return your entire kit to Hewlett-Packard for recharacterization.

REPLACEABLE PARTS

The frontispiece illustration shows the HP or Maury Microwave Corporation part numbers for all components of this kit. Components having a Maury part number must be ordered from Maury, not from HP. Maury is the original equipment manufacturer for some items in this kit.

To order an HP part, list the description, HP part number with check digit (CD), and quantity desired. Send your order to the nearest Hewlett-Packard sales/support office listed inside the back cover of this manual.

To order a Maury part, list the description, Maury part number, quantity desired, and indicate that these parts are for use in an HP 85051A 7mm verification kit. Send your order to Maury Microwave Corporation, 8610 Helms Avenue, Cucamonga, California 91730 (telephone 714-987-4715; TWX 910-581-3408).

ENVIRONMENTAL REQUIREMENTS

Thermal stability is essential if high-performance measurements are to be made. As the temperature changes, the mechanical dimensions of these devices also change, affecting their electrical performance. The specifications for the HP 8510 network analyzer are based upon an ambient temperature of 20 – 26°C (68 – 79°F) for the calibration, with all subsequent measurements being made within $\pm 1^\circ\text{C}$ ($\pm 1.8^\circ\text{F}$) of the calibration temperature. Therefore, if *all* HP 8510 specifications are to be met, all calibration, verification, and operating procedures should be performed within the specified temperature range.

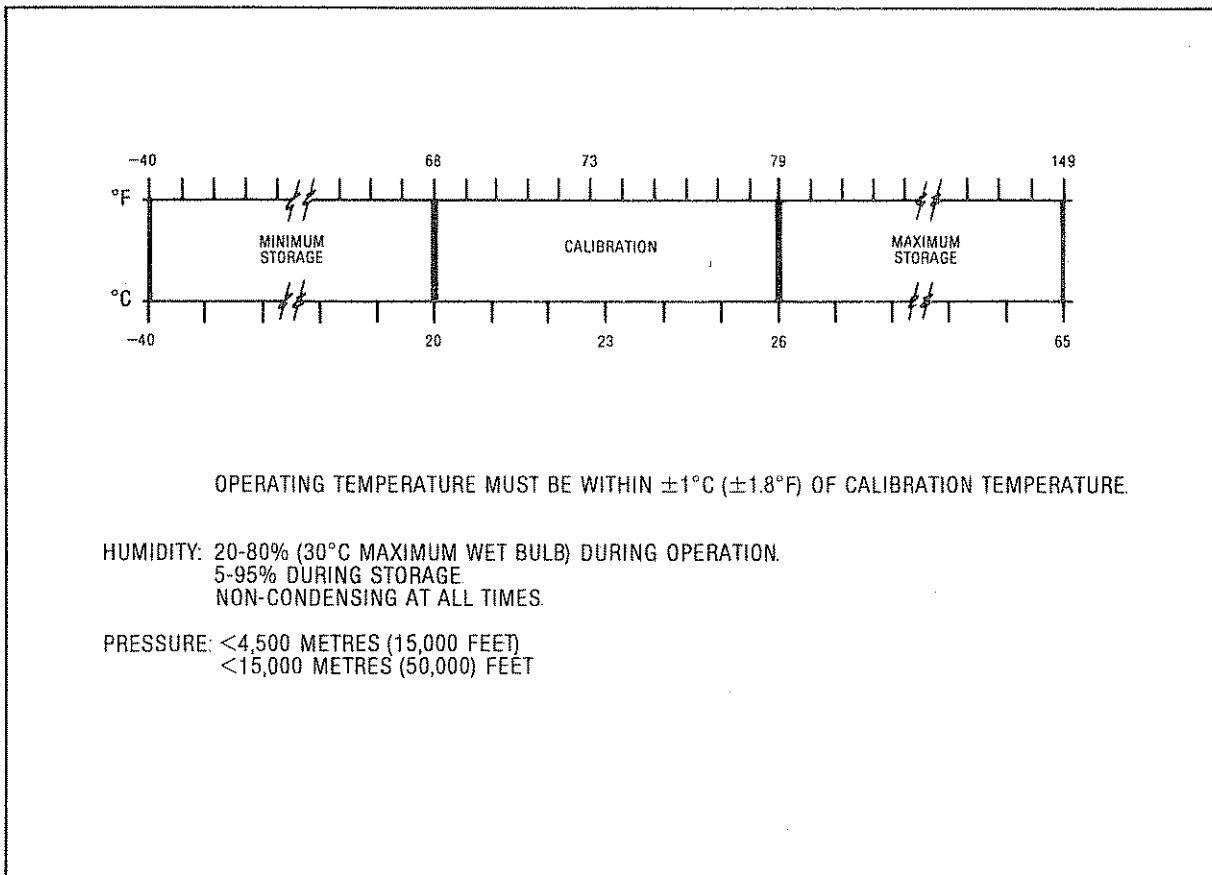

SAFETY CONSIDERATIONS

Good safety practices include the following:

1. Place a grounded, conductive work pad in front of the test ports.
2. Wear a grounded, anti-static wrist strap whenever you are working with the network analyzer.
3. Always grasp the outer shell of the test port just prior to making a connection, to discharge any static electricity that might be on your hands.
4. Handle all calibration and verification components gently, and store them properly.

CAUTION

Your body nearly always has a static charge to some degree. You are usually not aware of this charge, because the human threshold for the perception of a static-discharge shock occurs at approximately 3000 volts (the large shocks you get during the cold, dry winter months can be 15,000 volts or higher). You would not feel a static discharge of a few hundred volts, but such a discharge could damage sensitive microcircuits.

TYPICAL WORKSTATION

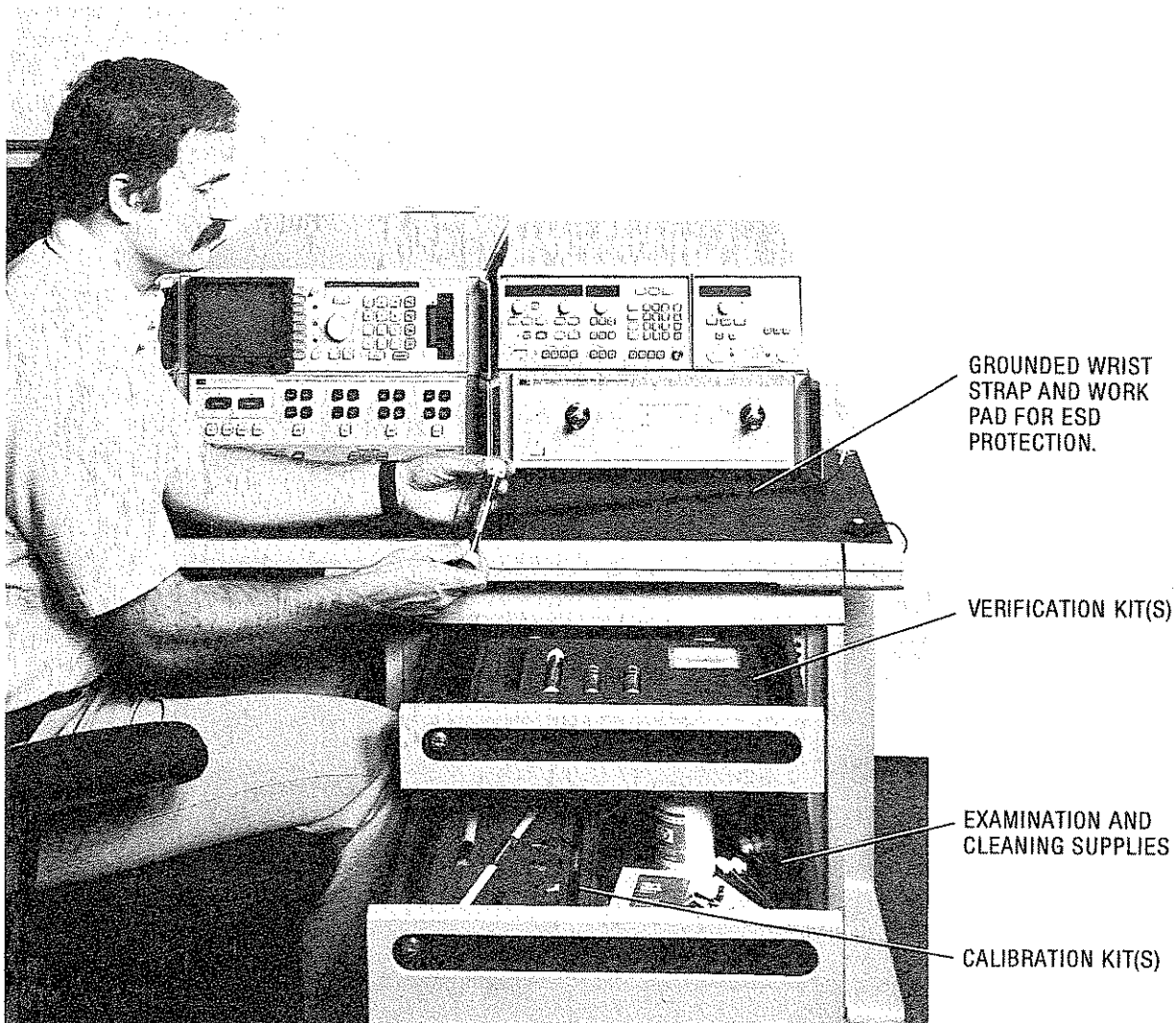

DEVICE SAFETY

SLIDE COVER
←
TO DETACH

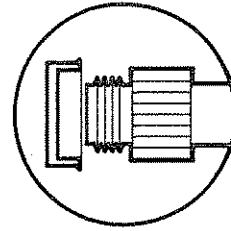
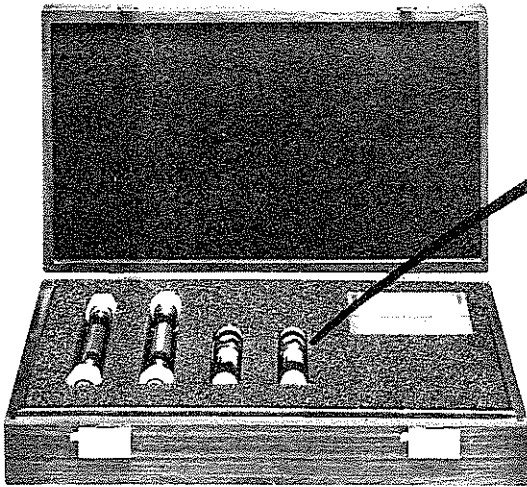

EXTEND THREADS TO PROTECT THE CONTACTING SURFACE, AND USE A PROTECTIVE CAP.

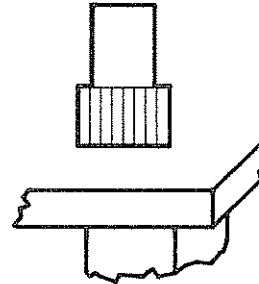

ALWAYS STORE THE DEVICES IN THEIR FOAM-LINED STORAGE BOX. THE COVER DETACHES TO ALLOW PLACING THE BOX IN A DESK DRAWER.

DO NOT PLACE DEVICES CONTACT-END DOWN ON A TABLE TOP, OR PLACE THEM LOOSE IN A DRAWER.

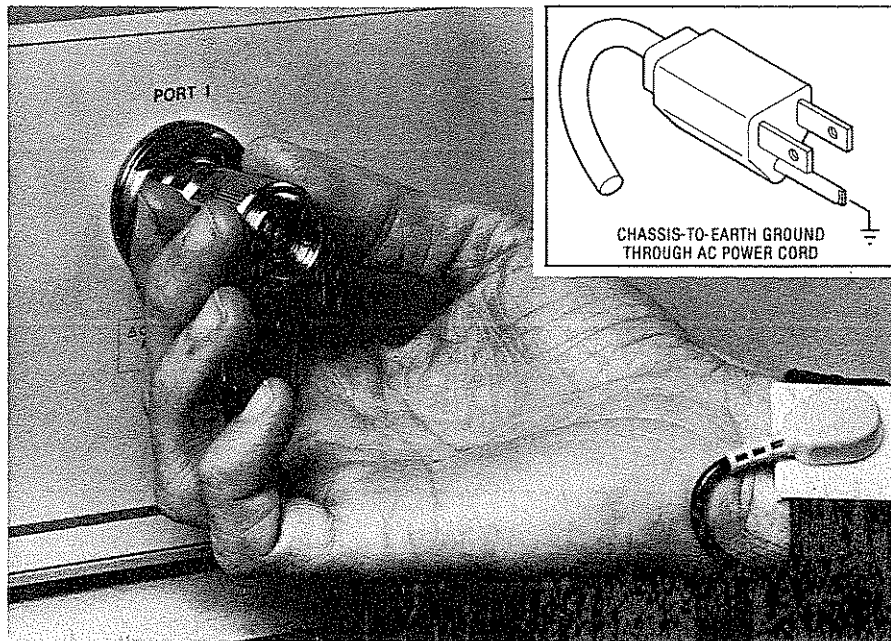

PORT 1

CHASSIS-TO-EARTH GROUND THROUGH AC POWER CORD

ALWAYS GRASP THE OUTER SHELL OF THE TEST SET CONNECTOR (NOT THE INNER ELEMENTS!) JUST PRIOR TO MAKING A CONNECTION. THIS WILL DISCHARGE ANY STATIC ELECTRICITY ON YOUR BODY BY PROVIDING A CONDUCTIVE PATH TO AN EARTH GROUND.

THIS IS THE MOST EFFECTIVE SINGLE SAFEGUARD YOU CAN USE TO PREVENT ESD DAMAGE TO YOUR INSTRUMENTS.

VISUAL AND MECHANICAL EXAMINATIONS

All microwave connectors – 7mm, 3.5mm, SMA, and others – must be examined from time to time both visually and mechanically. The visual examination should be done often, especially if high-performance measurements are being made. The mechanical examination should always be done when a new connector is being used for the first time, and when a measurement produces unexpectedly poor results. Otherwise, mechanical examinations are necessary only occasionally to keep track of normal connector wear.

VISUAL EXAMINATION

Use a high-quality, illuminated magnifying glass for the examination. Look for scratches or roughness on the mating surface of the outer conductor (which indicates excessive tightness during counter-rotation), as well as evidence of deformation on the shoulder of the center conductor. If any problem is observed, *immediately* remove that connector from service before it damages any other mating connector.

The quality of the illuminating light is crucial for the visual examination, because you are trying to see minute defects that are easily hidden by shadows. The power of the glass is less important; any power between 4 – 8 \times is sufficient.

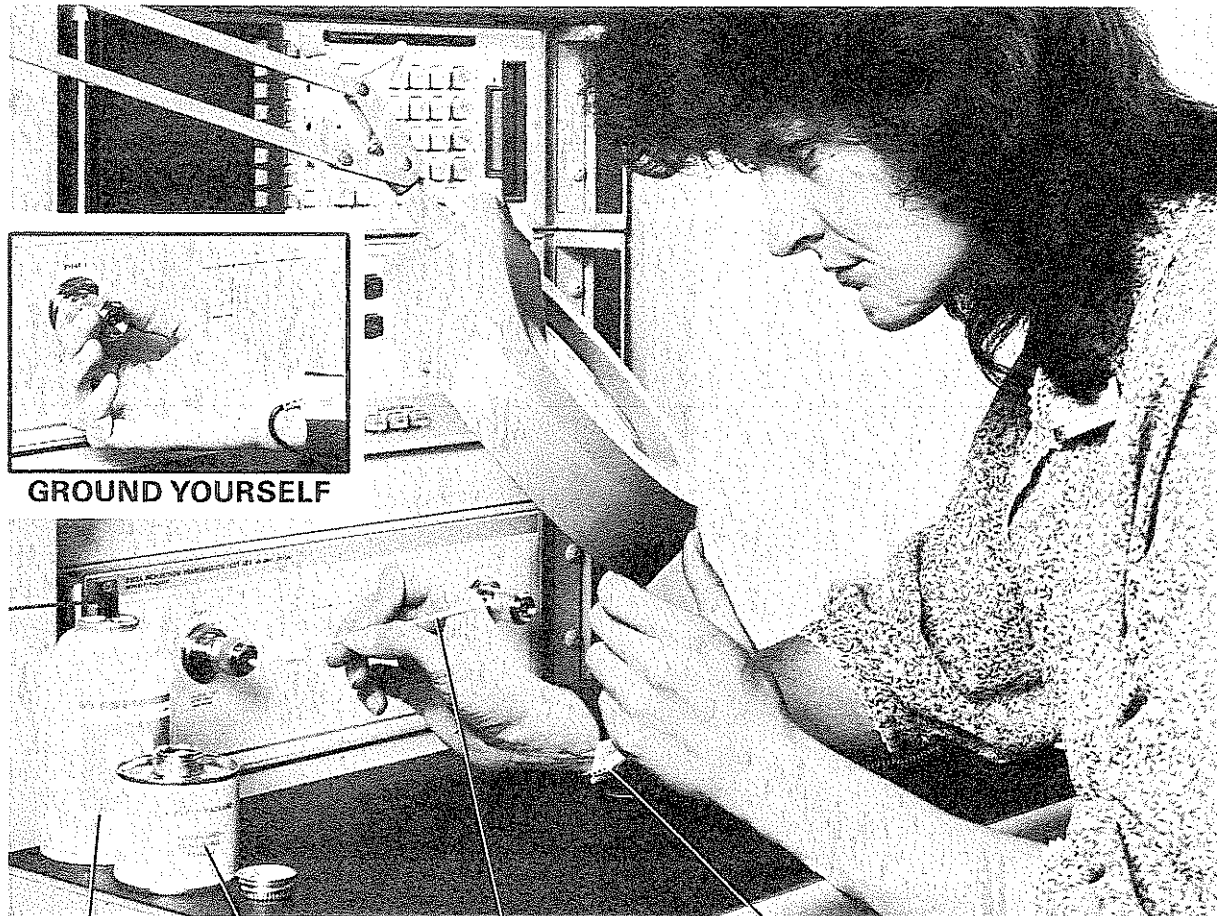

GROUND YOURSELF

COMPRESSED
AIR

TRICHLOROTRI-
FLUORETHANE

LINT-FREE
SWAB

GROUND
WRIST STRAP

EXAMINE THE CONNECTORS. CLEAN FIRST WITH COMPRESSED AIR, THEN TRICHLOROTRIFLUOROETHANE IF NECESSARY.

MECHANICAL EXAMINATION

This is the normal sequence for a mechanical examination of 7mm connectors:

1. Visually examine the gage and calibration block, just as you examine connectors, looking for dirt or damage. Screw the aligning pin into the gage. Zero the gage.
2. Remove the connector's 6-slot center collet.
3. Measure the connector. The allowable recession of the center conductor's shoulder varies with the type of device, but *no* protrusion is allowable on *any* connector.

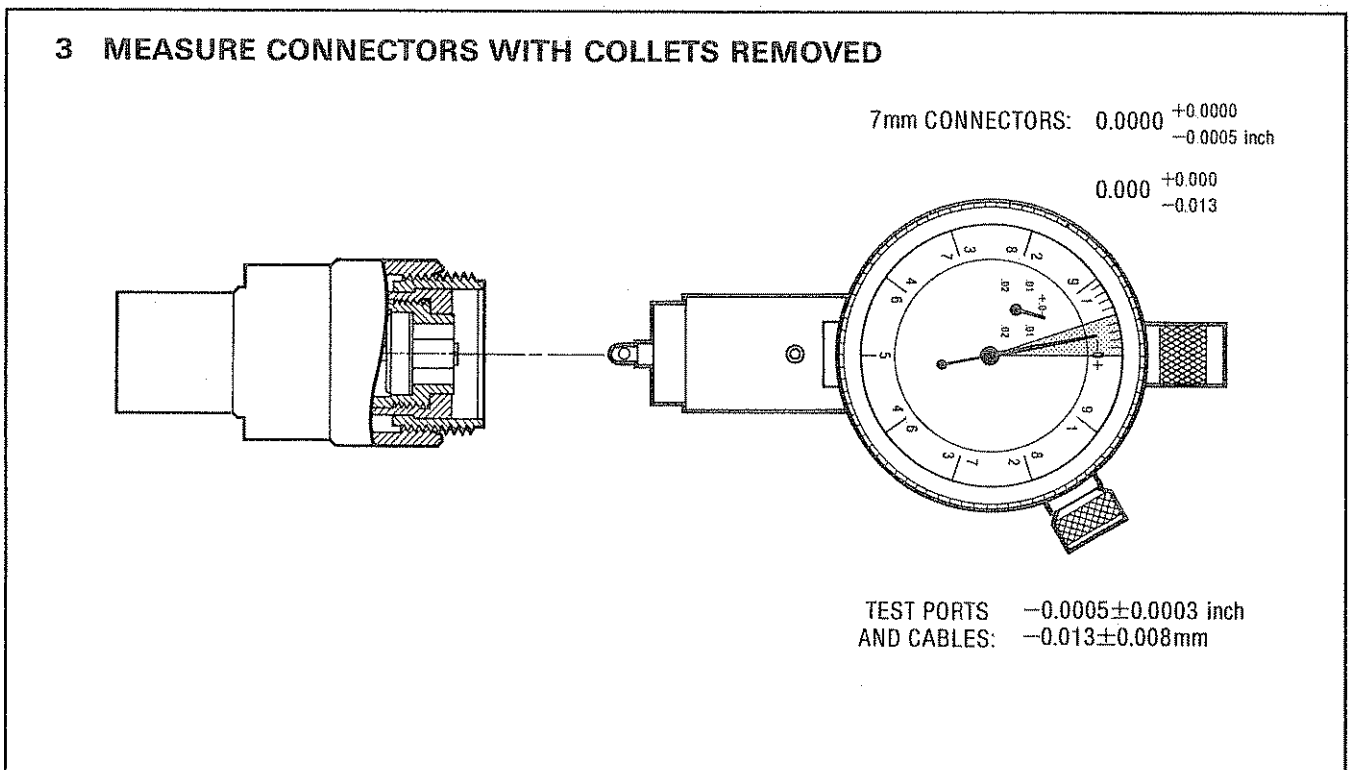
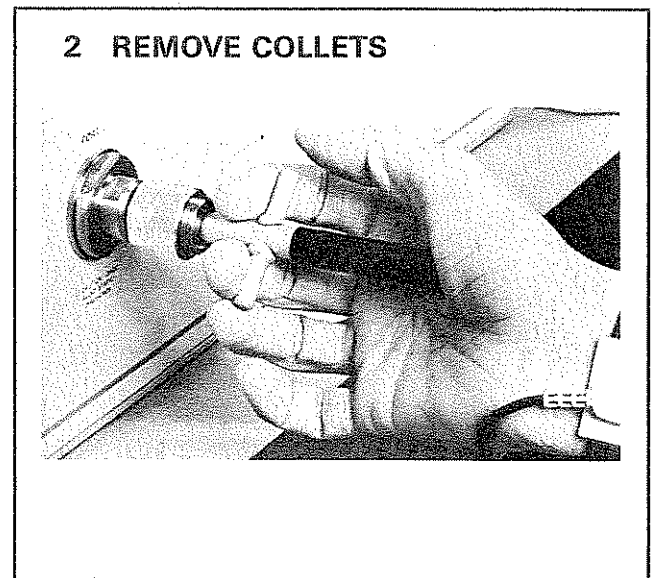
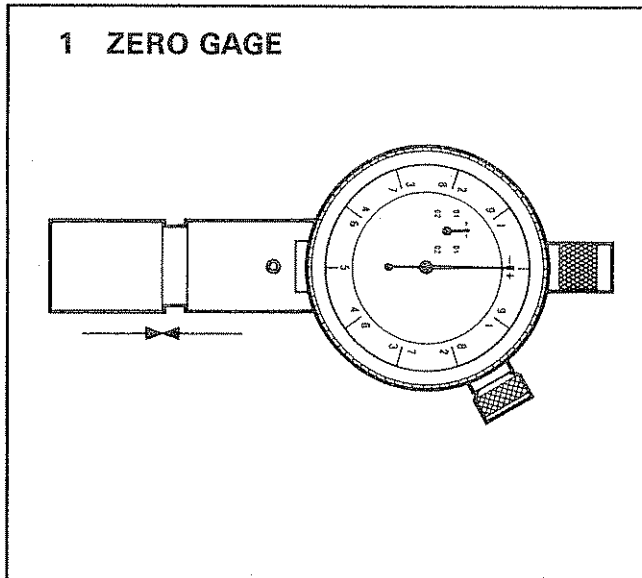

4. Replace the 6-slot center collet, and visually examine it to make sure that it wasn't damaged during removal or insertion (burrs, nicks, loss of roundness). Press on the collet to make sure that it will recess below the center conductor shoulder and then spring out when released.
5. Remove the aligning pin from the gage, and zero the gage on the flat side of the calibration block.
6. Measure the connector with the collet in place. The tolerance here is fairly large, as shown on the drawing, and in this case there must be a measurable protrusion of the center contact in relation to the outer conductor.

4 REPLACE COLLETS

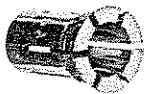
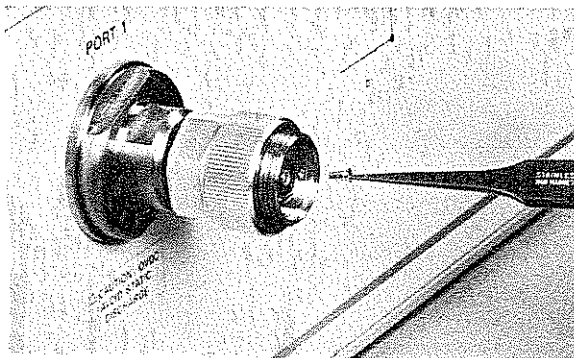

6-slot
collets ONLY

5 REMOVE ALIGNING PIN

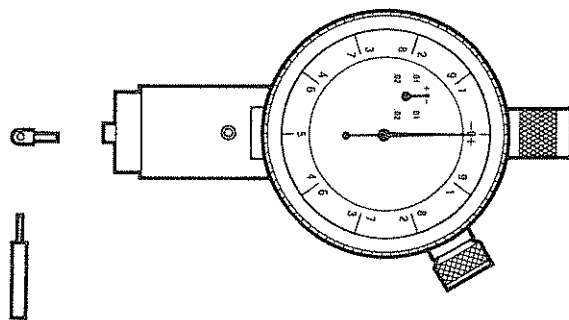

6 MEASURE CONNECTORS WITH COLLETS IN PLACE

ALL 7mm CONNECTORS: +0.002 to +0.010 inch
+0.05 to +0.25mm

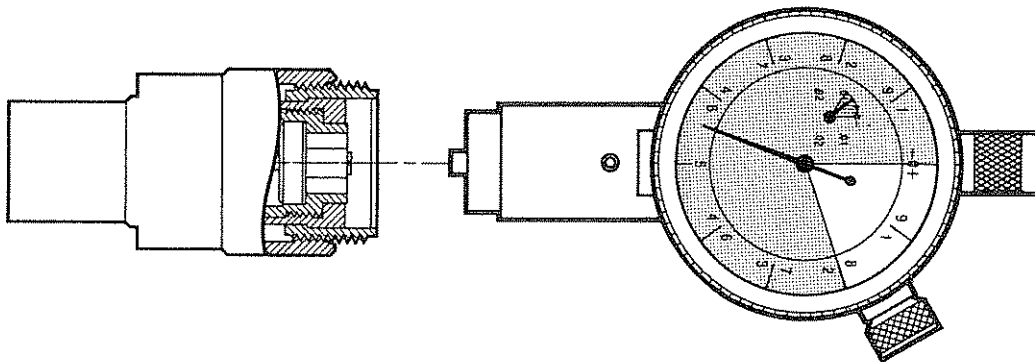

EXAMINATION FAILURES

If any connector fails either the visual or mechanical examination, *immediately* remove the connector from your work area. If a bad connector is mated to a good connector, the good connector might also be damaged even after only one mating.

BAD CONNECTORS

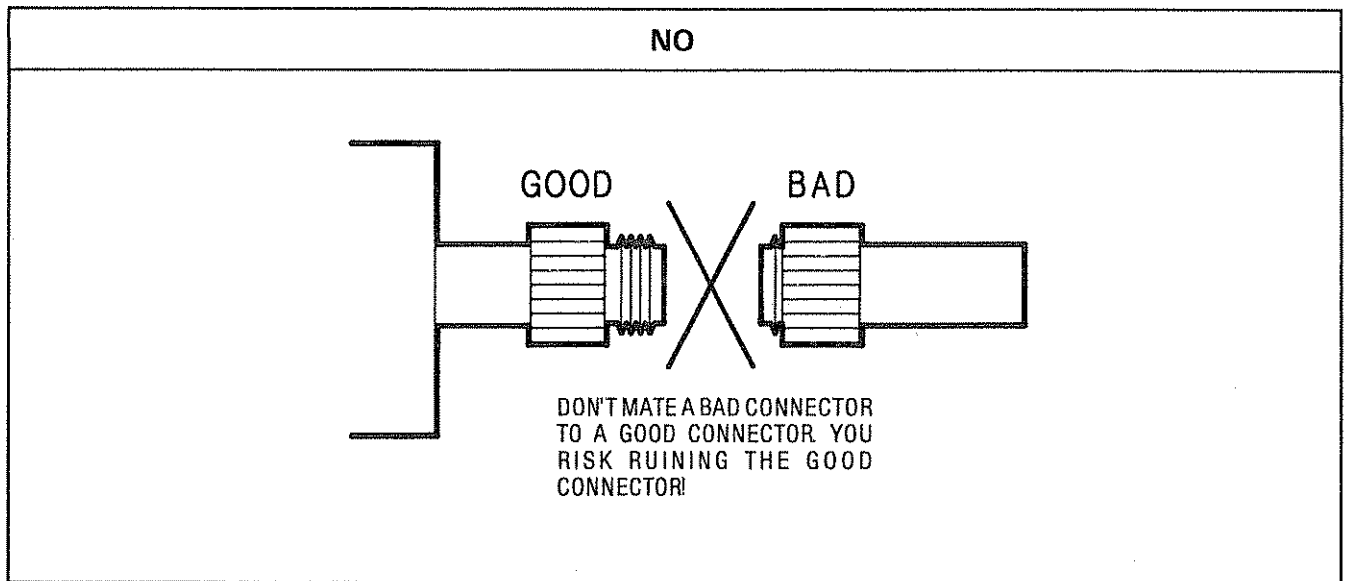
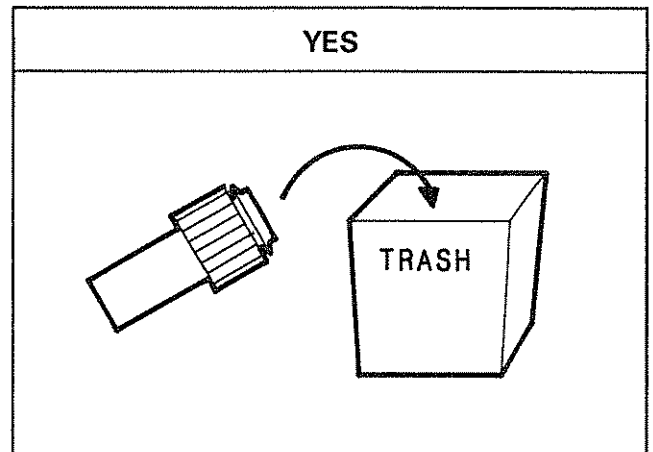
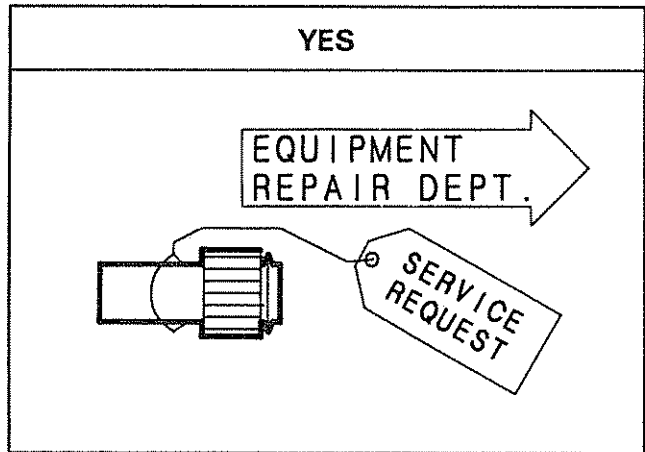

LOADING THE DATA CARTRIDGE

After completing the visual and mechanical examinations, load the verification data tape into the network analyzer as explained in Section IV (Performance Tests) of the HP 8510 network analyzer manual. A verification is usually performed by comparing your measured values for each device with typical values measured at the factory. The factory-measured values are stored on the data tape, as well as printed on the device performance data sheets. Your values and the factory values should be similar, within a tolerance range that is specified on the device data sheets. This tolerance range covers ± 3 standard deviations from the expected mean value.

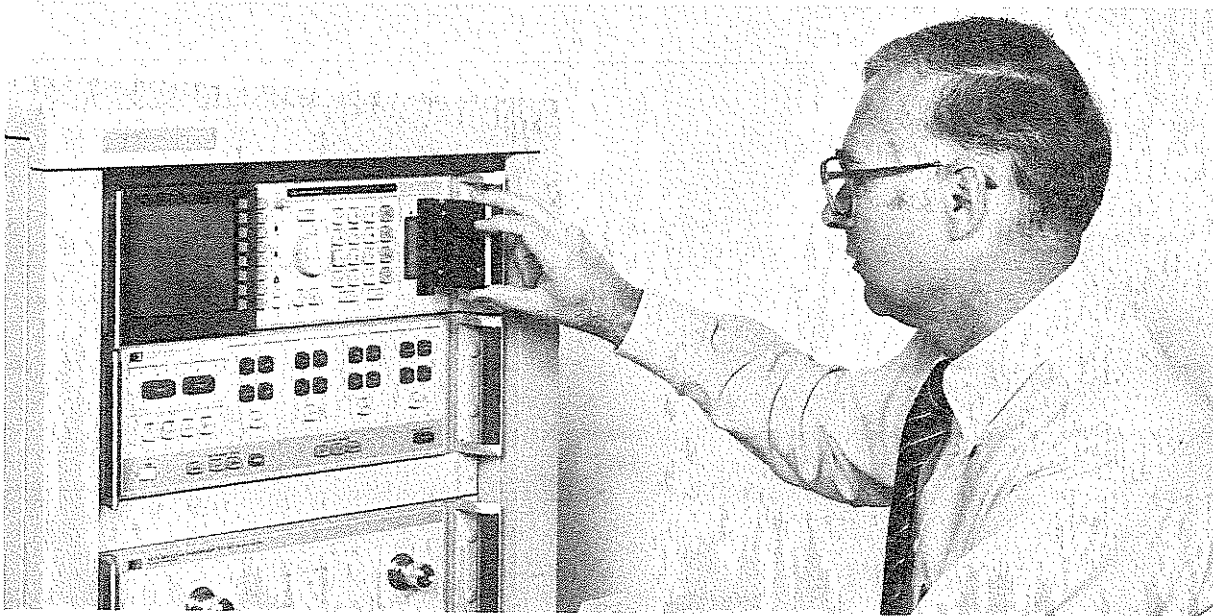

CONNECTION PROCEDURES

The quality of your measurements depends upon the quality of your connections. The following example shows procedures that will help you to obtain good connections.

First, lay out the cables, attenuators, and any other devices that you will need for your planned measurement, and extend or retract threaded sleeves as needed. This example shows two cables and a 20 dB attenuator (none of which are from the verification kit).

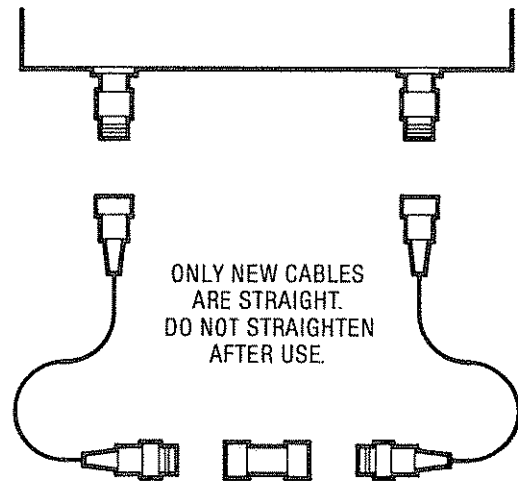

Next, lightly connect all joints except the one where the device under test (DUT) will be inserted. Later, we will use verification kit devices as DUTs.

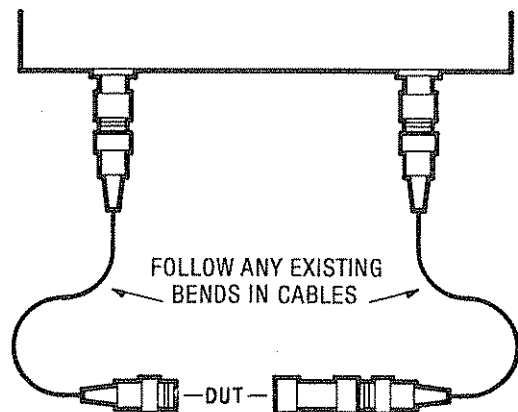

Now begin the final tightening of these preliminary connections. Keep cables as straight as possible, with gentle curves only ($>5''$ radius, *never* any sharp bends). And tighten connections that are furthest from the test ports first, so they can "float" (turn freely, without any change to their tightness) when you make later connections. Do not allow the cables to flop around.

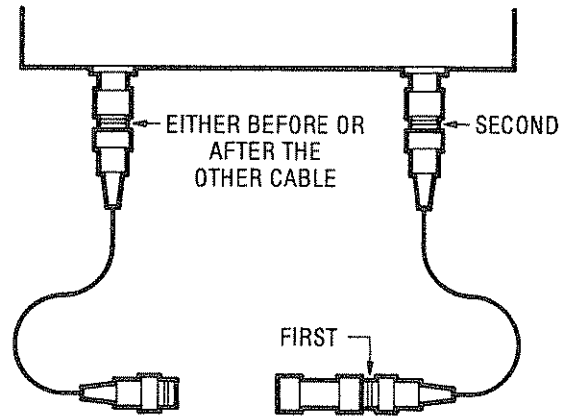

For each connection, counter-rotate approximately 10 degrees, then tighten with the 12 lb-in torque wrench. When all but the DUT connection has been made, place all cables and devices into the final position that will be used when measuring the DUTs.

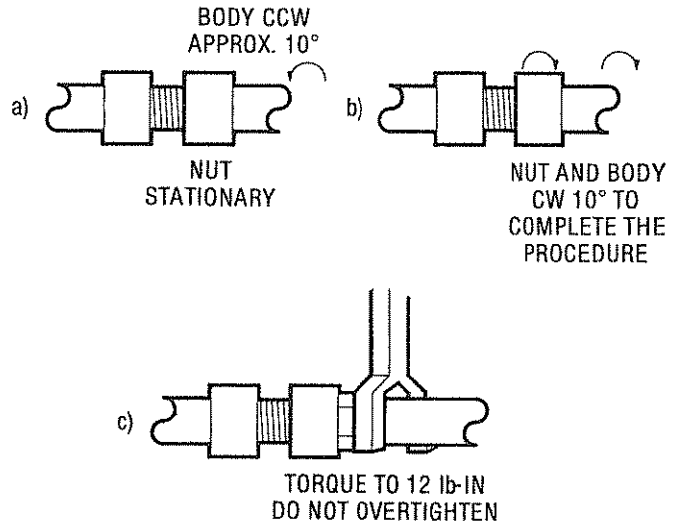

From this point on, **DO NOT CHANGE** the tightness of any connection or the bend of any cable, or you will also change the repeatability of your measurements! When you eventually remove the cables, do *not* straighten them, instead try to use the same curve for subsequent applications.

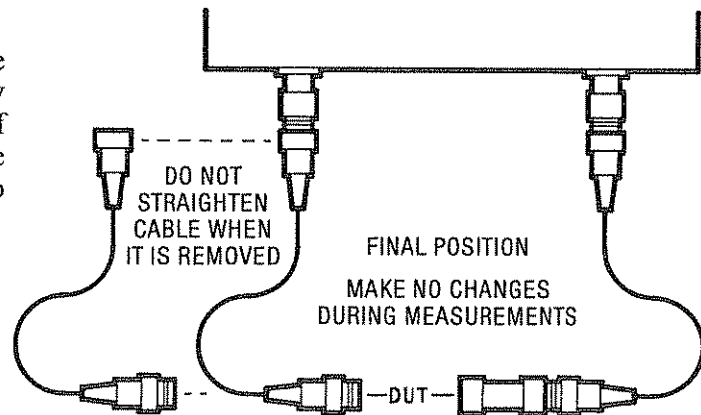

You are now ready to measure DUTs. The HP 85050A 7mm calibration kit devices are usually the first "DUTs" measured, and they are measured at the end of the test port 1 cable. Afterwards, measure the verification kit devices.

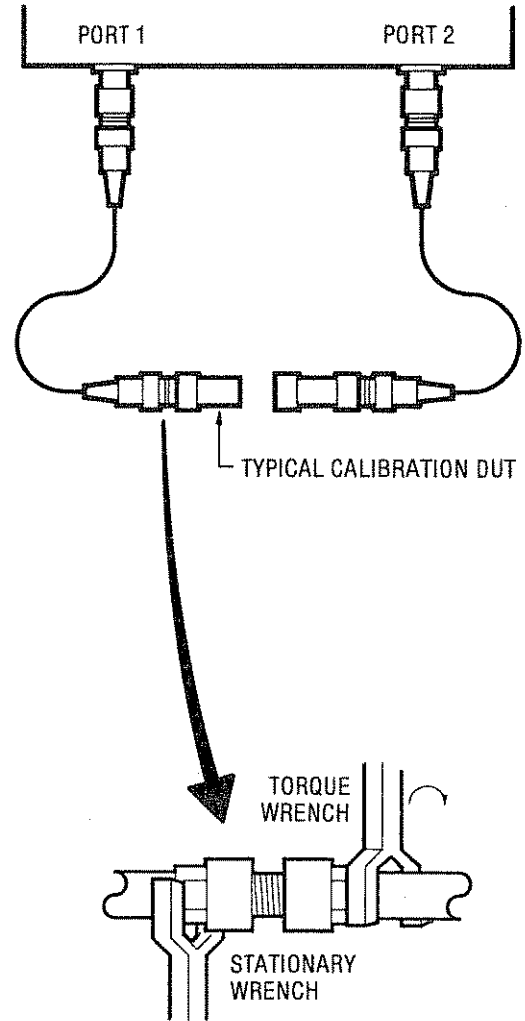

For each DUT measurement, counter-rotate approximately 10° , then complete the tightening with the 12 lb-in torque wrench. Be careful that you do not change any other connection when you are attaching the DUT. If necessary, use a thin-blade, open-end wrench (typically $9/16"$, 15mm), to hold the existing cables or devices stationary while you add the DUT. Use *great care* that you do not overtighten the connection when you are using two wrenches.

TYPICAL VERIFICATION RESULTS

Two verification examples are shown in this manual. Both show a plot of the memory data (from the data tape), a plot of the measured values, and a comparison of memory versus measurement (a difference for linear measurements, a ratio for logarithmic measurements).

Both examples were measured over the frequency range of 100 MHz to 20.1 GHz, for two reasons: First, a frequency overrange more clearly indicates what happens at the frequency endpoints (typically 18 GHz for 7mm connectors). Second, the vertical graticule lines indicate an even 2 GHz increment at this frequency range, which makes it easy to interpret the graph.

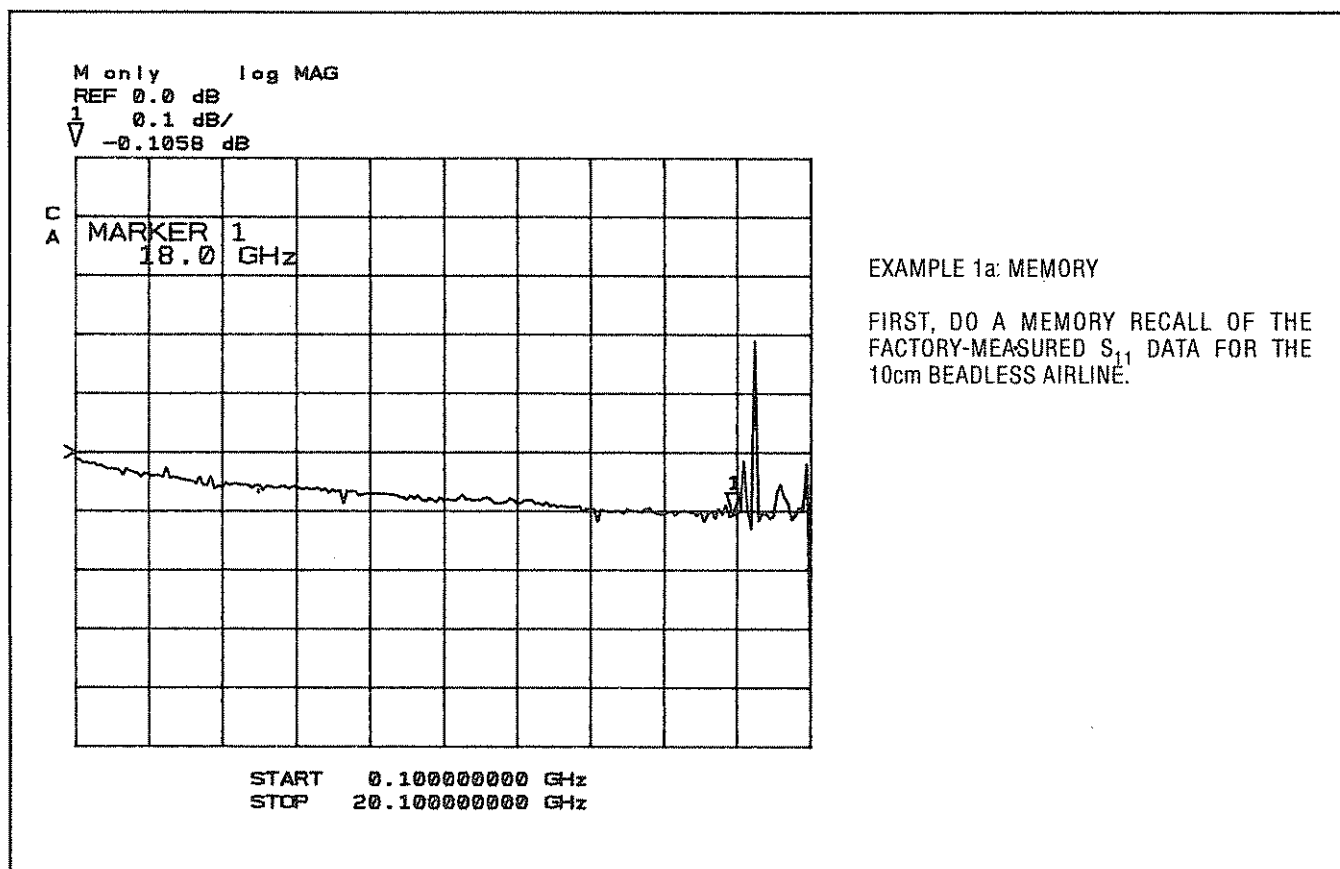

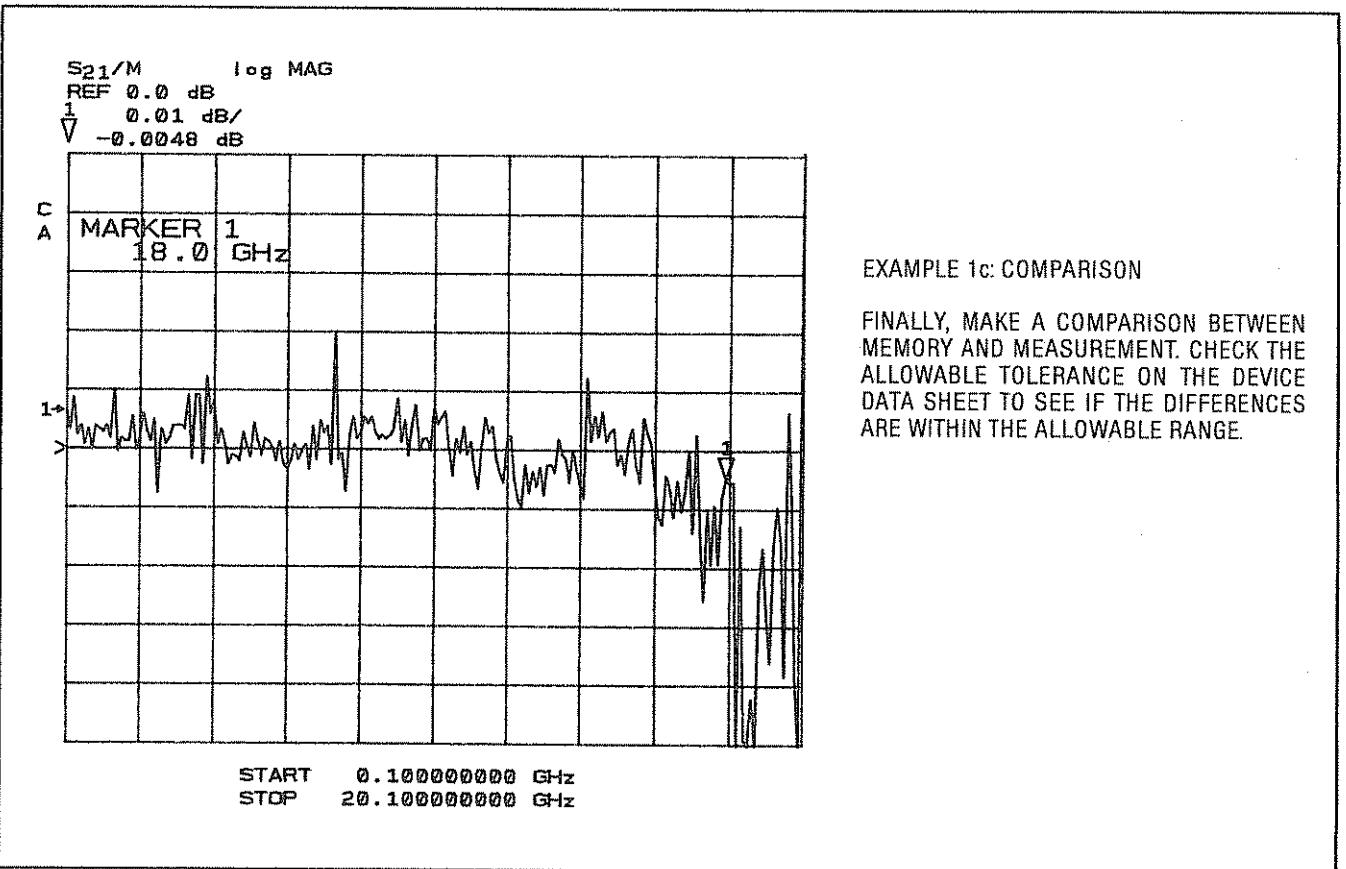
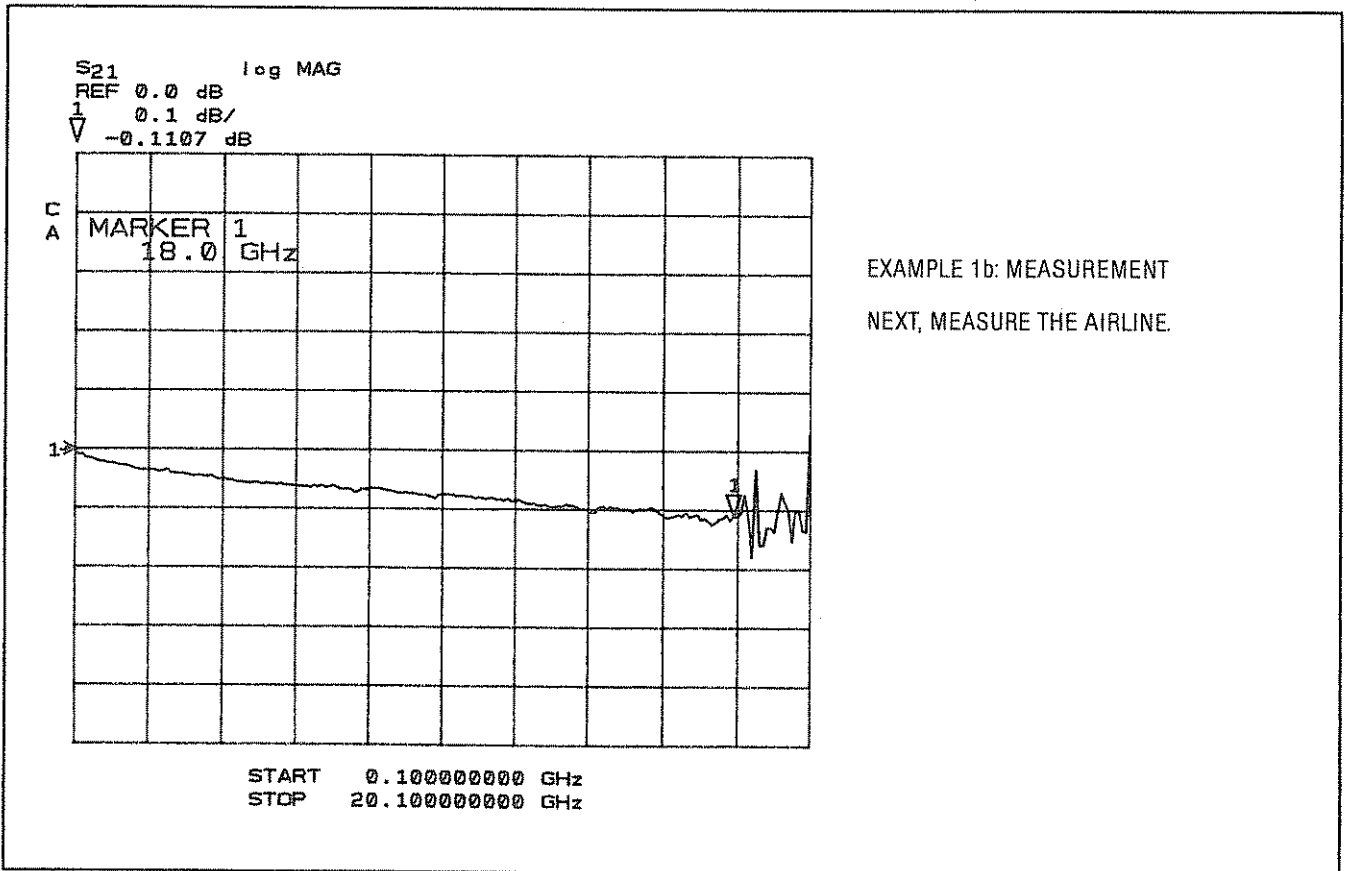

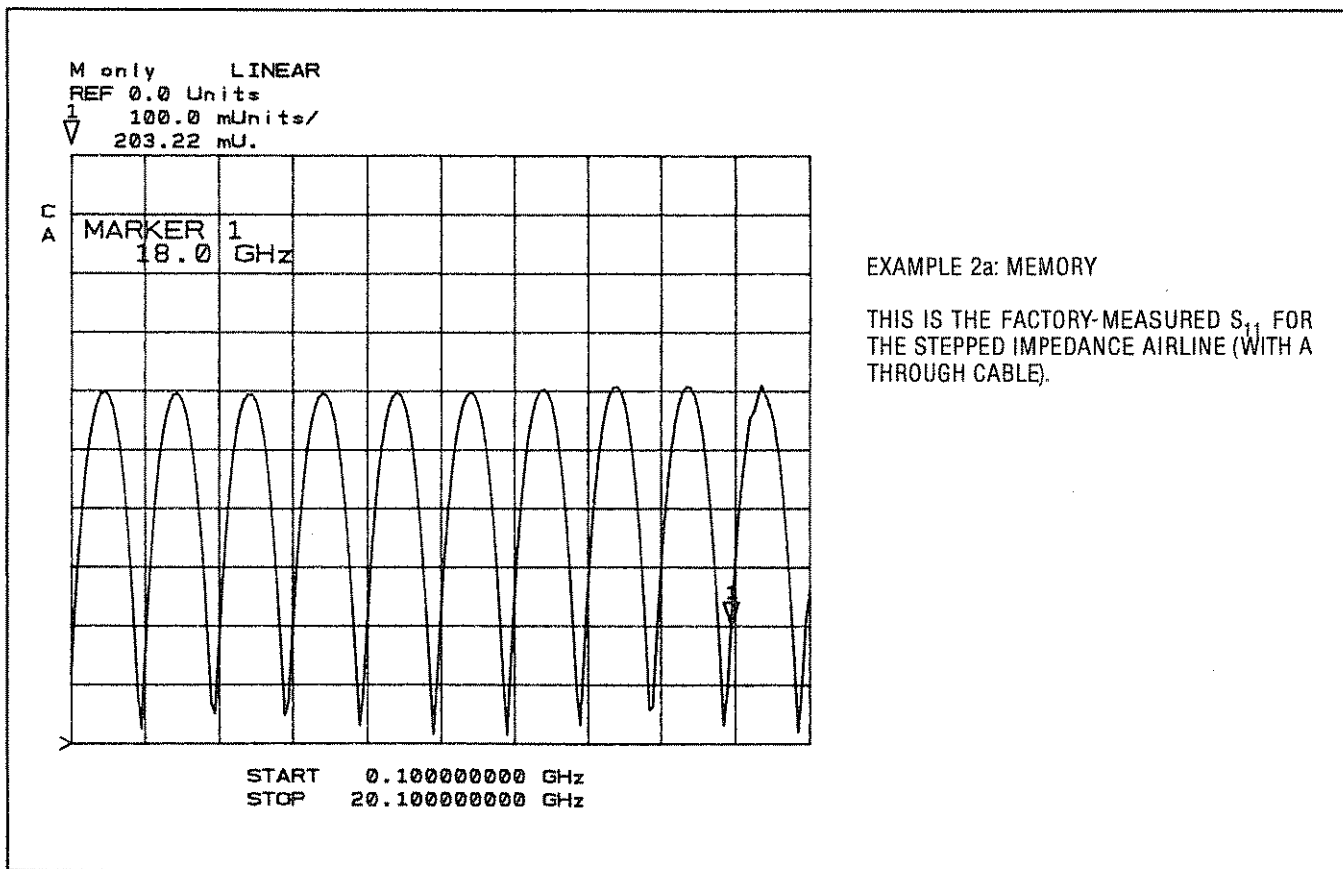

EXAMPLE 2a: MEMORY

THIS IS THE FACTORY-MEASURED S_{11} FOR THE STEPPED IMPEDANCE AIRLINE (WITH A THROUGH CABLE).

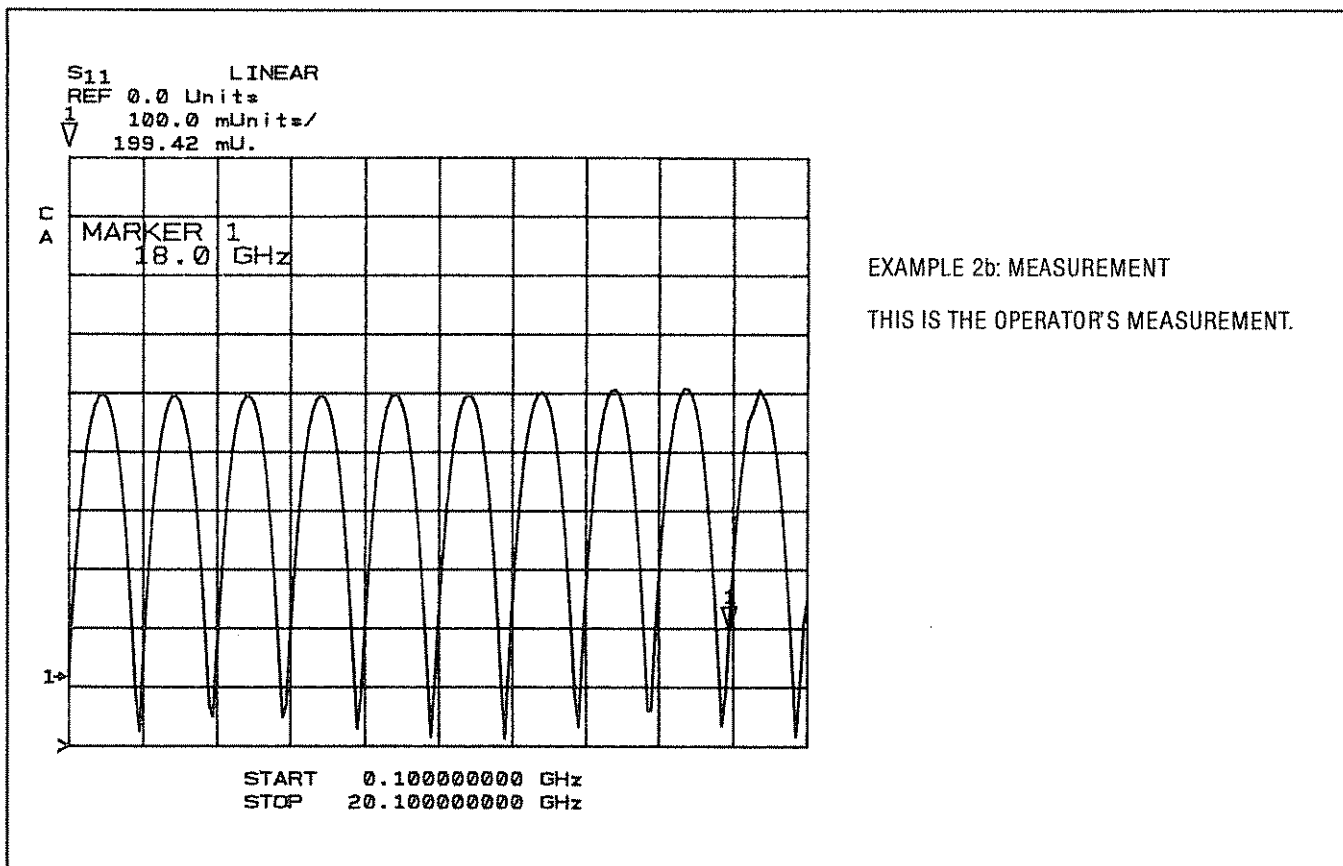

EXAMPLE 2b: MEASUREMENT

THIS IS THE OPERATOR'S MEASUREMENT.

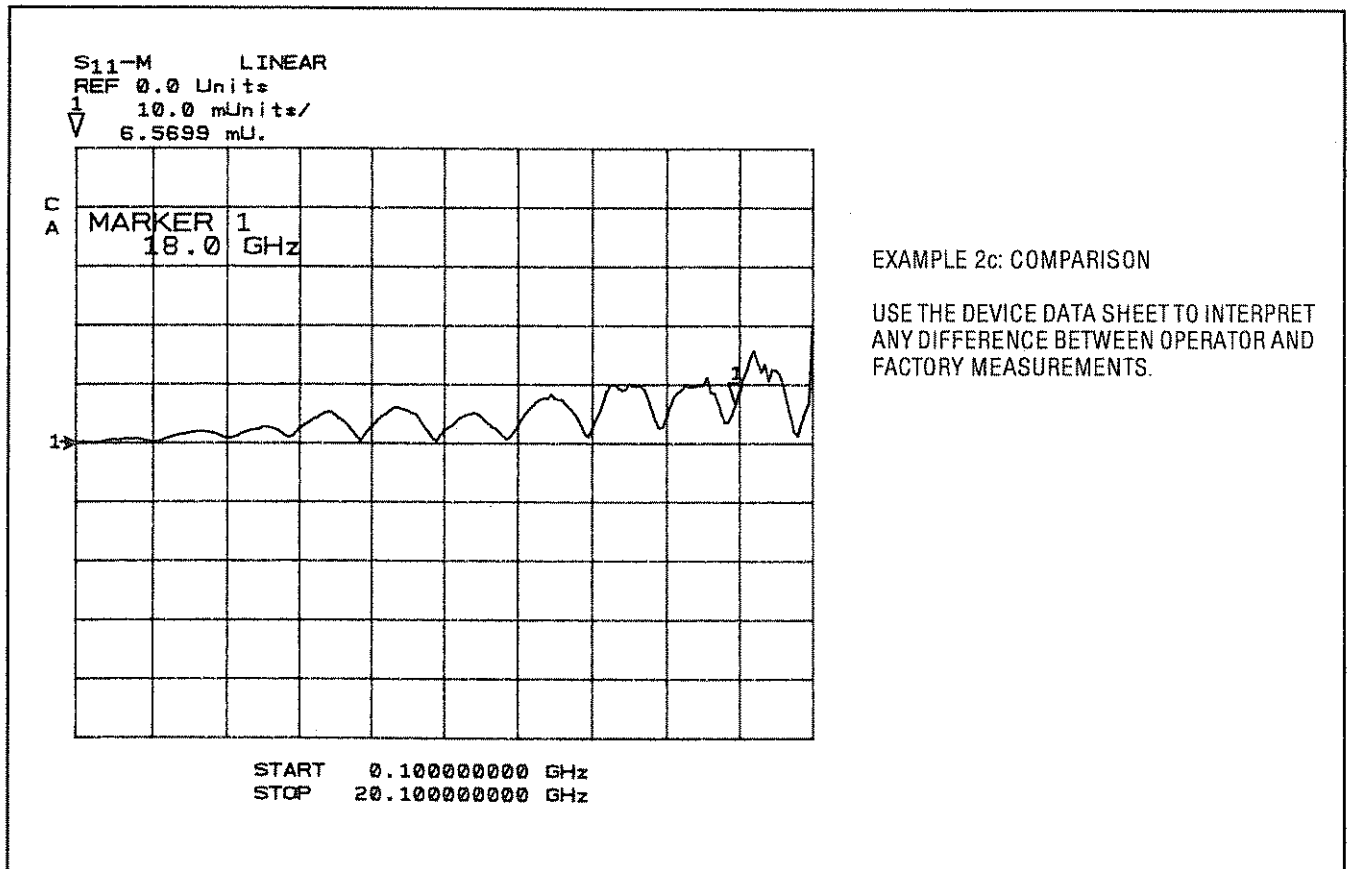

MECHANICAL DIMENSIONS

The HP 85050A 7mm calibration kit manual describes a procedure for mechanically measuring the calibration devices, then computing their expected electrical performance based upon their geometry. The following table provides the essential dimensions for the two verification kit airlines if you also want to mechanically measure them.

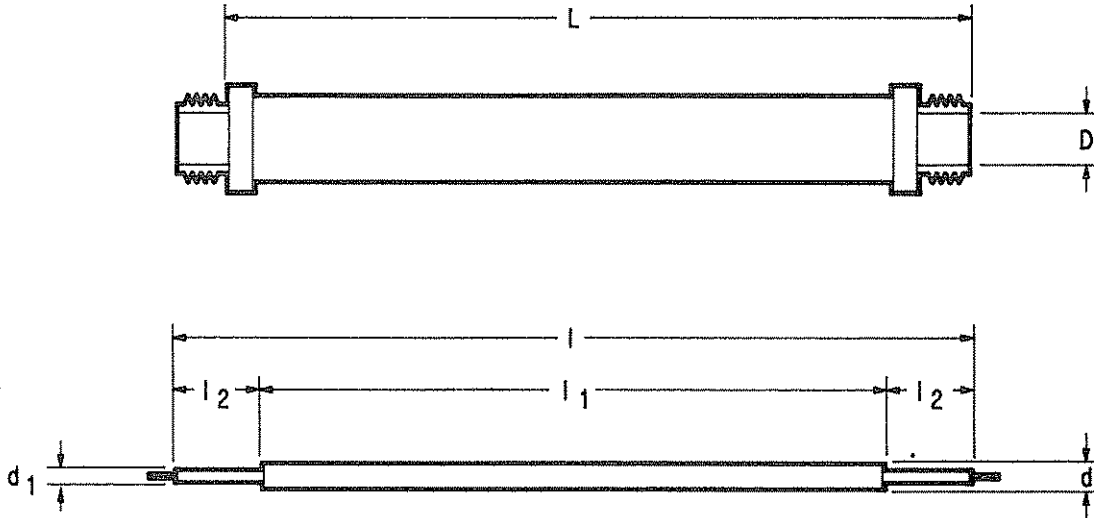

NOTE: l = length

Airline	Inner Conductor					Outer Conductor	
	d	d_1	l	l_1	l_2	D	L
10cm Airline 1250-1880	$d=d_1$			NA	NA		
Stepped Impedance 1250-1882	0.1816 ± 0.0002 $4.613 \pm 0.005\text{mm}$			2.950 ± 0.001 $74.93 \pm 0.03\text{mm}$	0.491 ± 0.001 $12.48 \pm 0.03\text{mm}$		
Both Airlines		0.1197 ± 0.0002	$l=L$ $+0.0000$ -0.0005			0.2756 ± 0.00025	3.9325 $+0.0005$ -0.0000
		$3.040 \pm 0.005\text{mm}$	$l=L$ $+0.0000$ -0.013mm			$7.000 \pm 0.006\text{mm}$	99.886 $+0.013$ -0.000mm
	Uniformity (largest diameter minus smallest diameter): 0.0002 0.005mm					Uniformity: 0.0004 0.010mm	
Straightness (diameter change/unit length): $0.0003/\text{inch}$ $0.003\text{mm}/\text{cm}$					Straightness: $0.0002/\text{inch}$ $0.002\text{mm}/\text{cm}$		

NA = Not Applicable

CONNECTOR LIFE

The useful life of a precision 7mm connector ranges from a few hundred to a few thousand connections, depending on exactly how those connections are made. The light burnishing you see on the gold-plated mating surfaces of your connectors after a few connections is normal, and in fact desirable because it shows that good contact is being made. Eventually that "burnishing" becomes "wear," and a gradual degradation in performance will occur.

By monitoring the performance change of your devices with time, and by visually examining the contacting surfaces on a regular basis you can tell how fast the surfaces are wearing and estimate when it will be necessary to order a new verification kit.

FURTHER INFORMATION

If you need additional information, here are four sources:

1. The HP 8510 network analyzer Operating and Service Manual is a comprehensive guide to calibration and verification procedures. The answers to most of your HP 8510-related calibration and verification questions should be in this manual.
2. HP publishes a "Manual Changes Supplement" whenever needed to keep manuals current. The supplements, which are available free upon request, correct any errors or omissions in the manuals and describe any manufacturing changes to the equipment.
3. HP also publishes a series of network analyzer "application notes," which are usually available free from your local HP office. Ask your HP representative for an application note index.
4. Your local HP representative is always willing to help. Business cards for local representatives are placed in Volume 1 of the HP 8510 manual, and a general list of HP Sales/Support offices is included at the end of every HP manual.

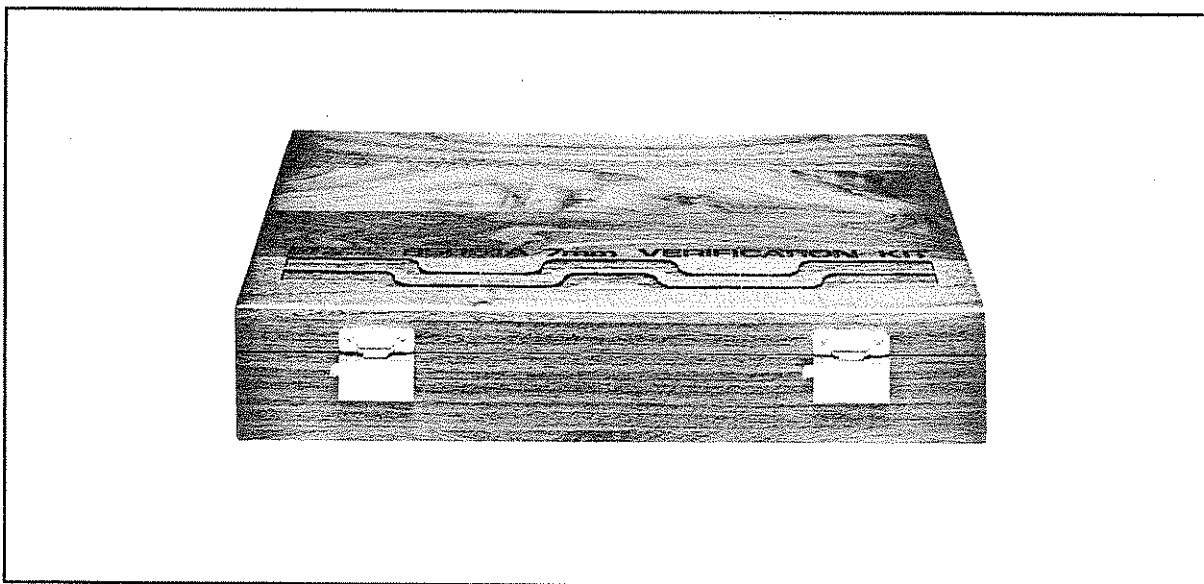

1
2
3
4
5
6
7
8
9
10
11
12
13
14
15
16
17
18
19
20
21
22
23
24
25
26
27
28
29
30
31
32
33
34
35
36
37
38
39
40
41
42
43
44
45
46
47
48
49
50
51
52
53
54
55
56
57
58
59
60
61
62
63
64
65
66
67
68
69
70
71
72
73
74
75
76
77
78
79
80
81
82
83
84
85
86
87
88
89
90
91
92
93
94
95
96
97
98
99
100

MANUAL IDENTIFICATION

Model Number HP 85051A
Manual Date April 1984
Manual Part Number 85051-90001

MANUAL CHANGES
HP 85051A 7mm Verification Kit

This Manual Changes supplement will bring you up to date on all new information, changes, and corrections that apply to the manual originally supplied with your HP 85051A 7mm verification kit. The information in this supplement applies to manuals which have the manual part number and date of printing given above. These should be the same as those on the manual you have. If not, you should request the Manual Changes supplement that does apply to your manual.

The information in this supplement applies to all HP 85051A verification kits. There are no serial-related changes.

[NEW] preceding an entry indicates that this information is appearing for the first time in a Manual Changes supplement, or that it has been changed or corrected since the last Manual Changes supplement was issued for the HP 85051A 7mm verification kit, on 19 October 1984.

Manual Changes supplements are revised as often as necessary to keep all Hewlett-Packard manuals as current and accurate as possible. Free copies are available from all HP offices, and it is recommended that you periodically request the latest Manual Changes supplements for all HP equipment that you are using. In each case, please give the model number, the date of the manual, and the manual part number given on the title page of your original manual. This information also appears at the top of the first page of all Manuals Changes supplements.



GENERAL NOTES - ALL SERIALS

Inspection and Cleaning, Counter-rotation Technique

Recent work at Hewlett-Packard has shown even more clearly that *it is essential to inspect and clean all connectors if accurate measurements are to be made.* Dirt and contamination on connectors is the most important single source of measurement problems.

In addition, it has been found that while the counter-rotation technique (10 to 20 degrees) described in this manual and in the HP 85050A 7mm calibration kit manual is required for the most demanding measurements (40 dB or more return loss, for example) it can be omitted if this degree of accuracy is not required (20 dB return loss, for example). Doing so will also reduce the slight connector wear that is naturally caused by the counter-rotation technique.

Mechanical Dimensions: Inner Conductor Setback

Several references are made in this manual to an inner conductor setback of 0.0000 to 0.0005 inches (0.000 to 0.013 mm) for 7mm connectors. This is a general guideline for you to consider when selecting precision devices, but there are many exceptions. Test port connectors have a greater recommended setback, sliding loads have a smaller setback, and some verification kit devices and most low-frequency devices have an extended allowable range for the setback values.

Both attenuators in this kit have been measured at the factory, and whatever setback they have is accounted for in the characterization data for each device. Therefore, the attenuators may have any setback between 0.0000 to 0.0020 inches (0.000 to 0.050 mm). Protrusion of an inner conductor, however, is never allowable on any 7mm connector.

3.5mm-to-7mm Adapters

If you wish to use 7mm calibration or verification devices with an HP 3.5mm test set (e.g. HP 8513A or HP 8515A), use only HP 85130A special 3.5mm (F) to 7mm adapters on the test ports for best results. The correct sequence is 3.5mm test set port - HP 85130A adapter - HP 85132A/B 7mm cable - 7mm calibration and verification devices.

The HP 85130A adapters have two special features: (1) the 3.5mm side is a special "NMD-3.5" connector designed specifically to mate with HP 3.5mm test set ports, and (2) the 7mm side has an inner conductor setback that matches the setback on HP 7mm test set ports. Other adapters may be used at non-port connections, to connect ordinary 7mm devices to ordinary 3.5mm devices.

The adapters in the HP 85052A 3.5mm calibration kit can, however, be used on 7mm test set ports (HP 8512A and HP 8514A test sets). These adapters were designed for a 7mm-to-3.5mm test port conversion, but not for a 3.5mm-to-7mm test port change.

HP 85051A 7mm Verification Kit
- ALL SERIALS -

CORRECTIONS - ALL SERIALS

[NEW]

Page 0, Part Numbers. The correct replacement part number for the 10cm beadless airline is HP 85051-60006 CD 7. The correct replacement part number for the center conductor tip is Maury Part Number 2600-65.

The correct replacement part number for the stepped impedance airline is HP 85051-60005 CD 6. The correct replacement part number for the center conductor tip is Maury Part Number 2600-65.

Characterization data is shipped with each device when a replacement is ordered; this data should be used instead of the data for the original device being replaced.

The correct replacement part number for the foam-lined storage case is HP 85051-80009 CD 2. This includes both the case and the foam insert.

Page 9, Figure 3. The metric units label (mm) was omitted by mistake. The allowable metric tolerance on 7mm connectors is $0.0000 +0.000/-0.013\text{mm}$.

Page 20, dimensions of the stepped impedance airline. The dimensions given in the table are correct. But on the drawing the dimension L is shown incorrectly. L should be extended so that it is the end-to-end overall length of the outer conductor including both threaded portions.

